

(25)

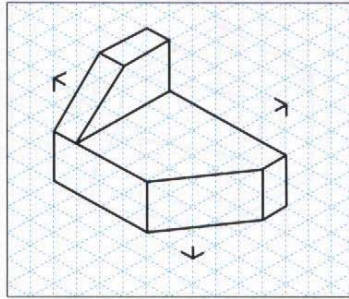

(26)

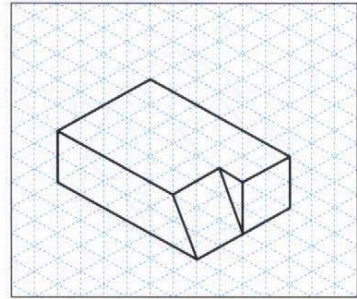

(27)

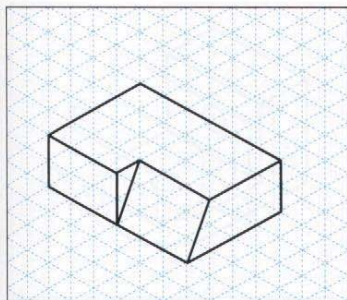

(28)

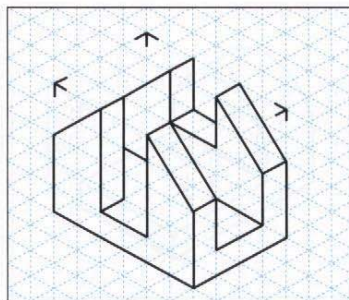

(29)

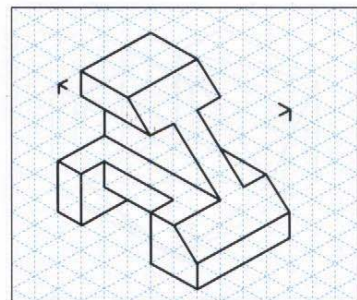

(30)

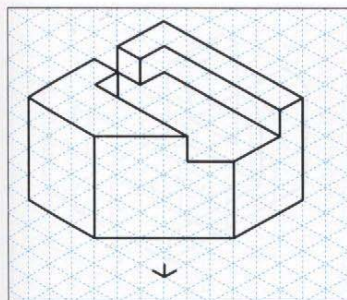

(31)

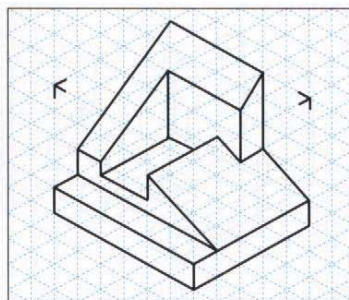

(32)

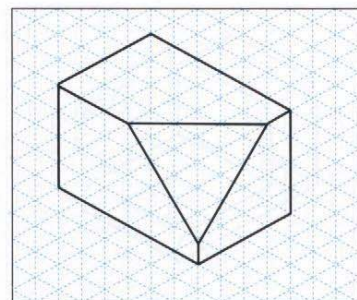

(33)

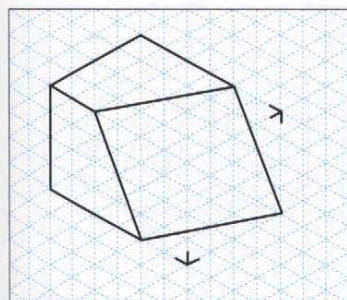

(34)

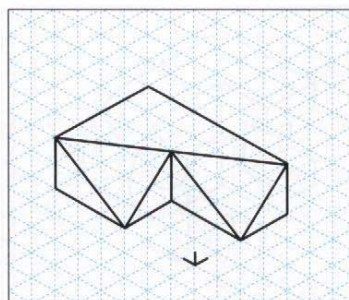

(35)

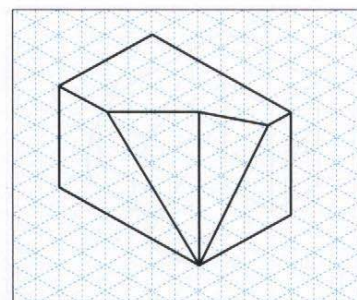

(36)

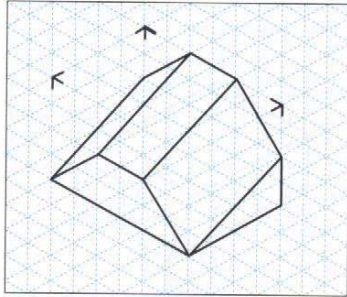

(37)

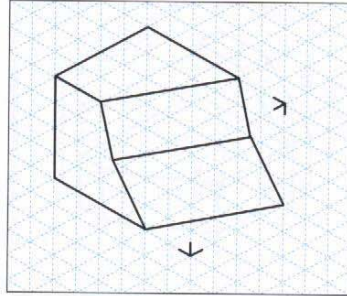

(38)

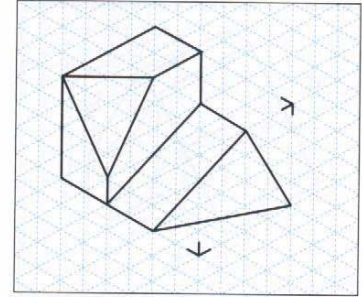

(39)

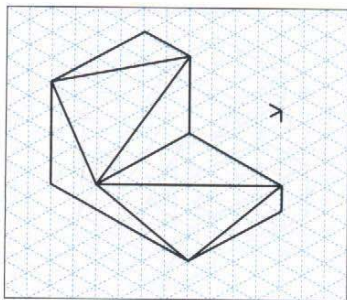

(40)

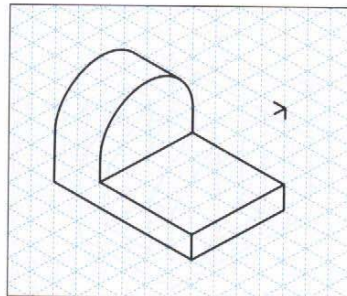

(41)

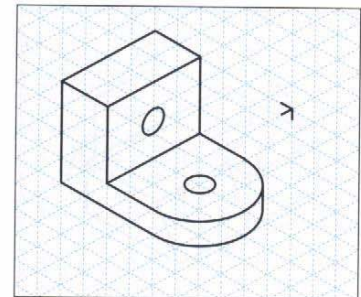

(42)

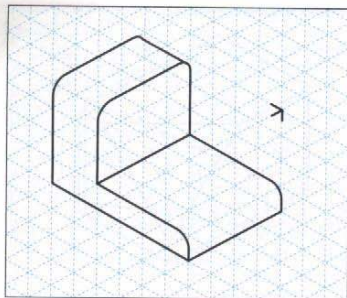

(43)

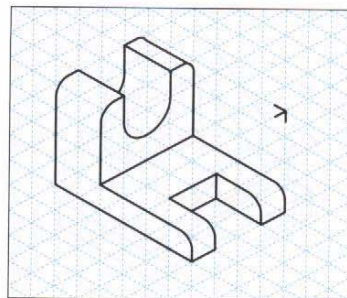

(44)

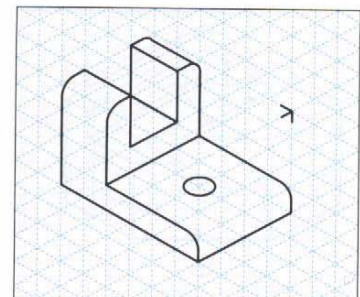

(45)

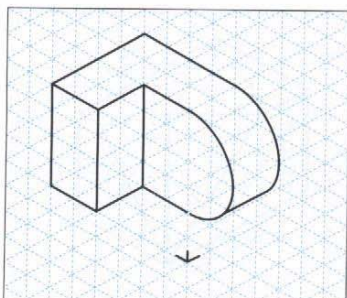

(46)

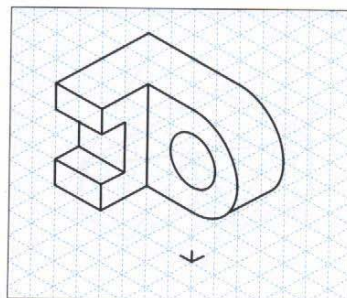

(47)

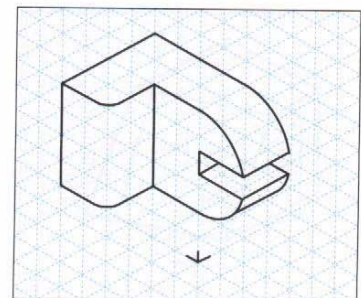

(48)

4.80D

Assume all holes to be through.

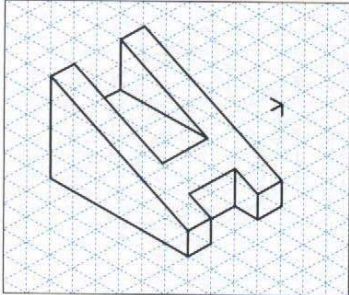

(61)

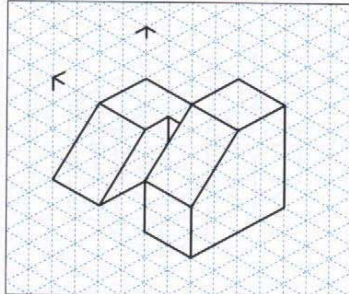

(62)

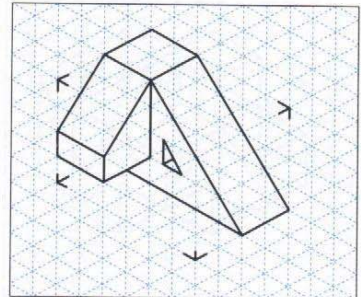

(63)

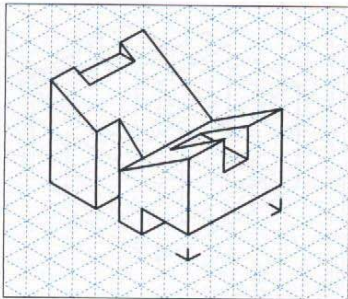

(64)

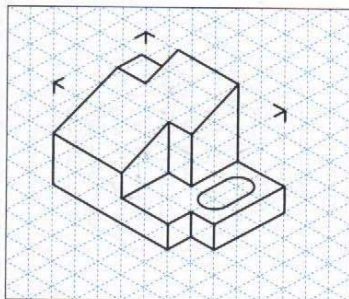

(65)

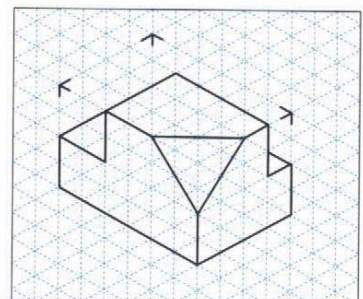

(66)

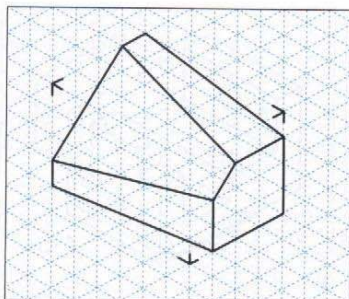

(67)

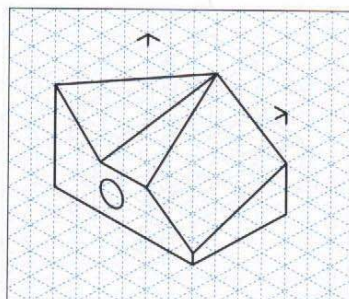

(68)

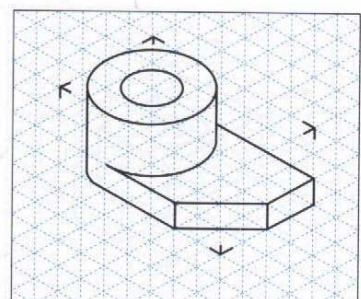

(69)

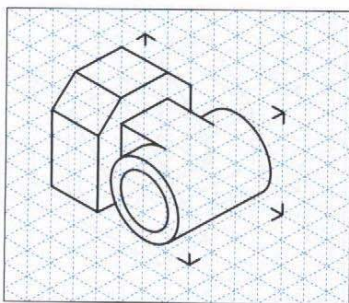

(70)

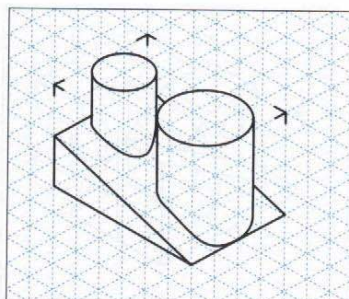

(71)

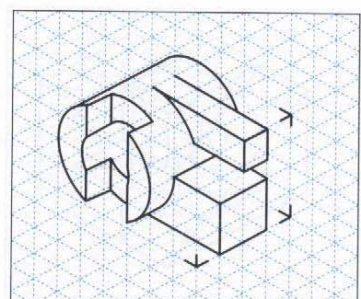

(72)

4.80F

Assume all holes to be through.

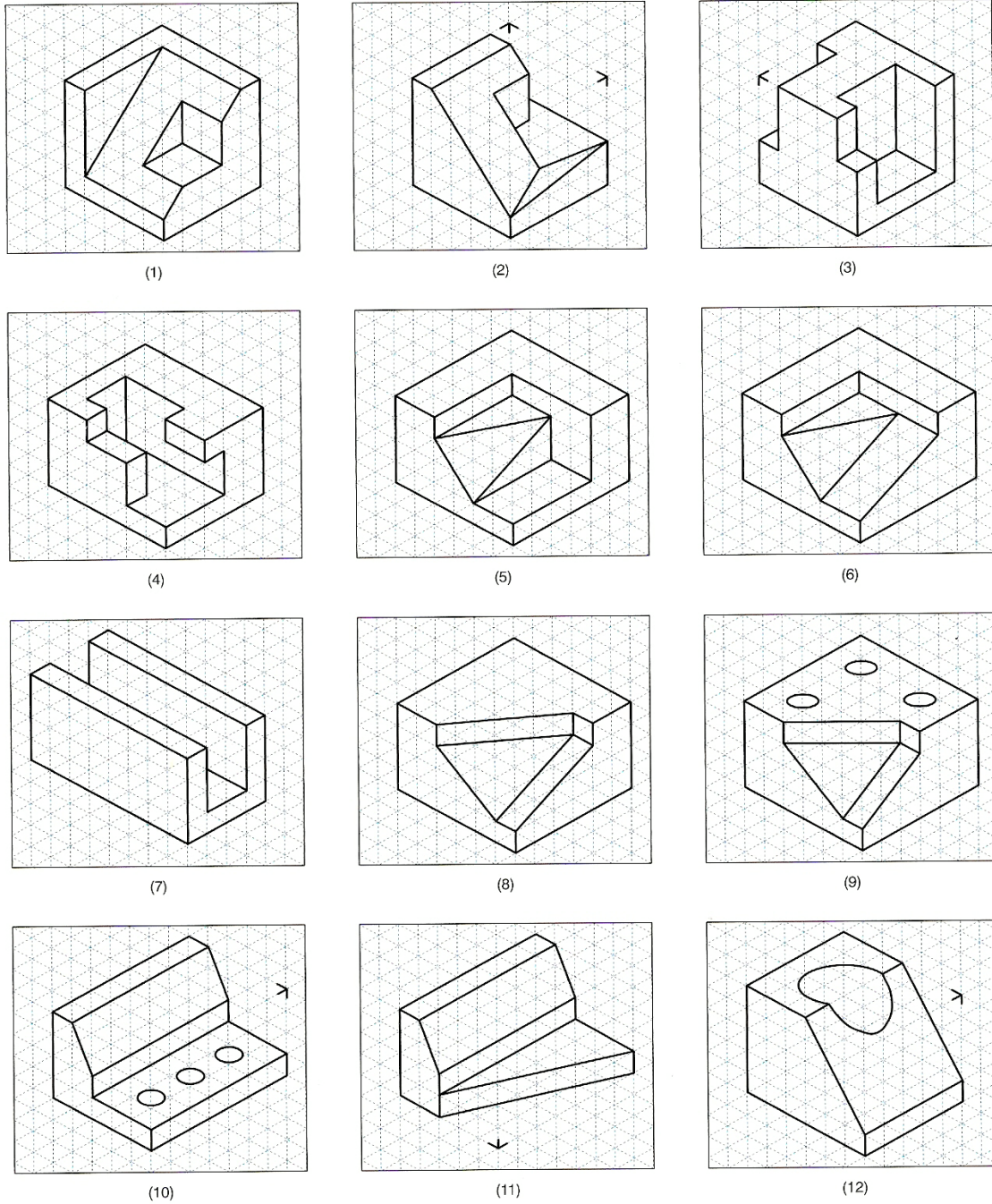
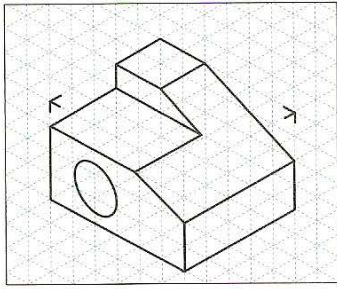
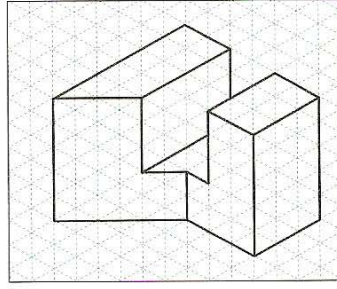

Figure 8.94 Pictorials of Several Objects for Problems 8.6 and 8.13



(13)



(14)

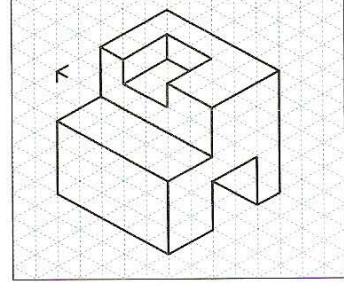

(15)

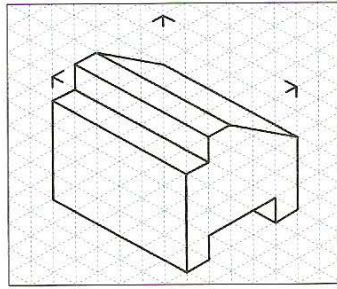

(16)

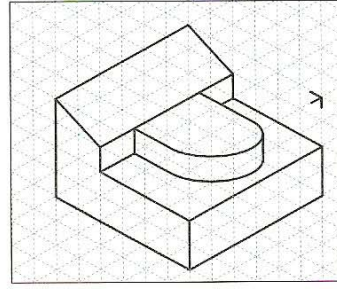

(17)

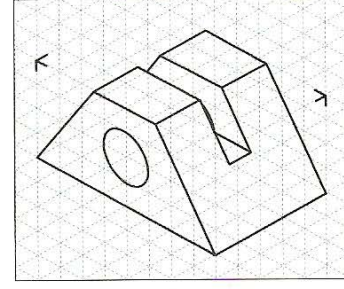

(18)

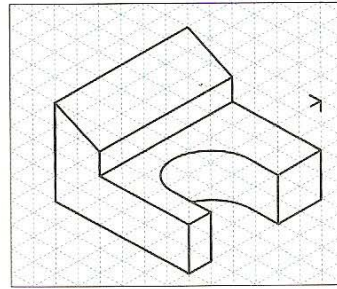

(19)

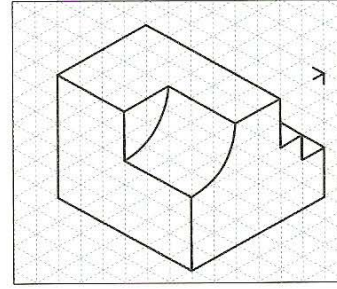

(20)

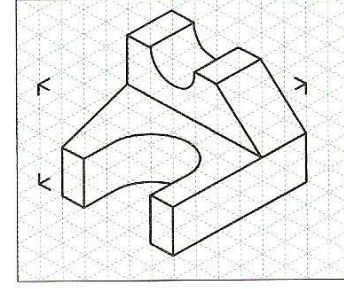

(21)

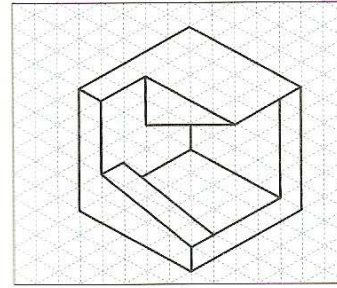

(22)

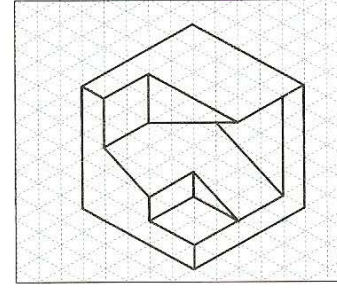

(23)

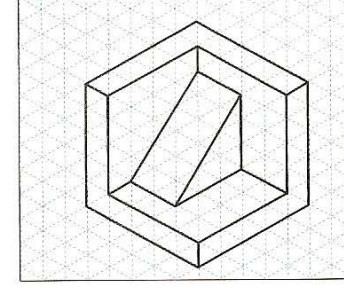

(24)

Figure 8.94 Continued

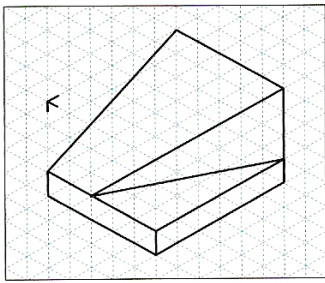

(25)

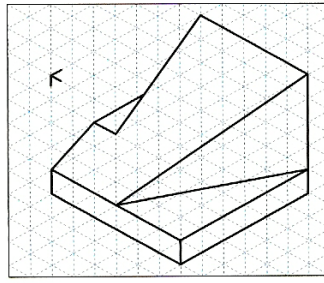

(26)

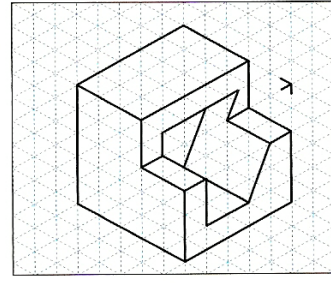

(27)

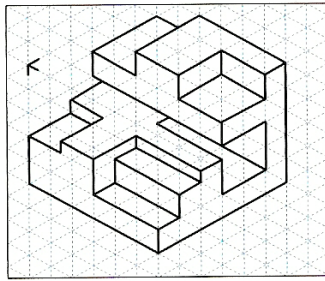

(28)

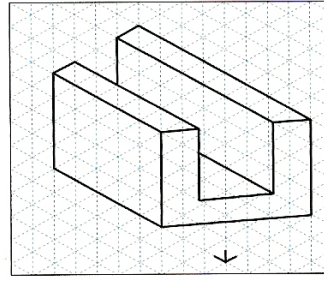

(29)

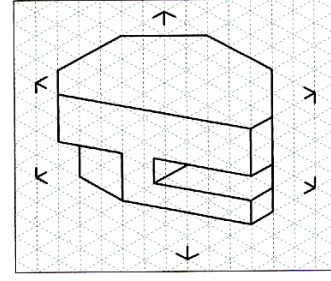

(30)

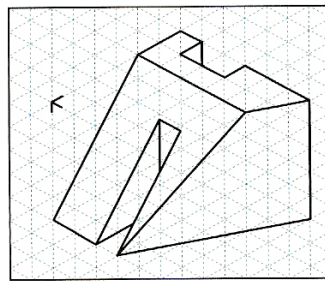

(31)

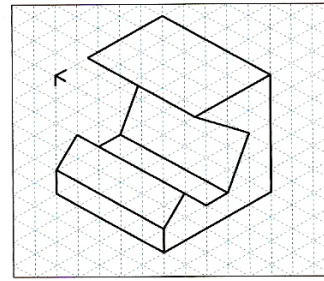

(32)

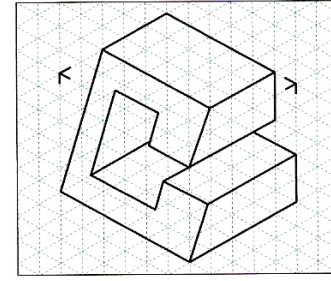

(33)

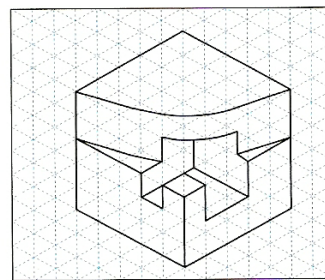

(34)

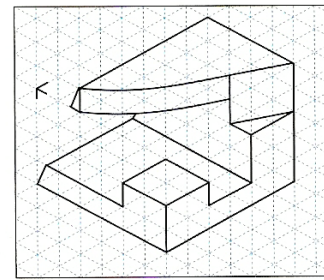

(35)

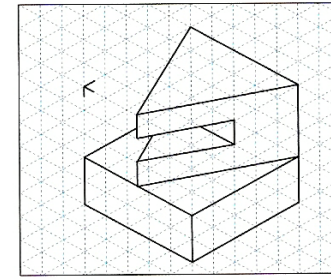

(36)

Figure 8.94 Continued